

### LED Intelligent Driver (CV)

- Leading edge (Triac), Trailing edge (ELV) phase-cut and Push DIM.
- With soft-on and fade in function, visual more comfortable.
- Dimming range: 0-100%, LED start at 0.1% possible.
- 0-100% flicker-free, High frequency exemption level.
- High Efficient driver: efficiency 88%,PF>0.98, THD<6%
- Innovative thermal management technology, intelligent power life protection.
- Over load / Over temp. / Short circuit / Over voltage protection, recover automatically.
- Suitable for internal lights application for I/II/III.
- Up to 50000-hour life time.
- 5 years warranty (Rubycon capacitor).

**Flicker-free**  
IEEE 1789  
High frequency exemption level

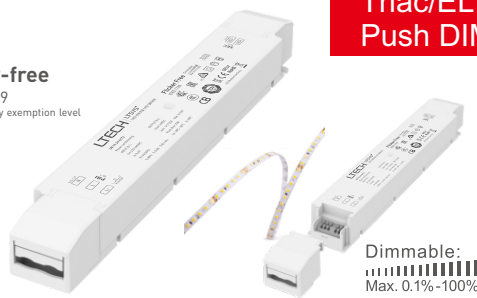

Dimmable:  
Max. 0.1%-100%



The certification icon represents undergoing certification applications only, and final certification qualification subject to actual product.



### Specification

Model	LM-75-24-G1T2	LM-75-12-G1T2	
OUTPUT	Output voltage	24Vdc	12Vdc
	Output voltage range	24Vdc ± 0.5Vdc	12Vdc ± 0.5Vdc
	Output current	Max. 3.125A	Max. 6.25A
	Output power	Max. 75W	
	Output power range	0~75W	
	Strobe level	High frequency exemption level.	
	Dimming range	0~100%, dimming depth: Max. 0.1%	
	Overload power limitation	≥102%	
	Ripple & Noise	≤150mV	
PWM frequency	3600Hz		
INPUT	Dimming interface	Leading edge (Triac), Trailing edge (ELV) phase-cut and Push DIM.	
	Input voltage	220-240Vac	
	Frequency	50/60Hz	
	Input current	230Vac≤0.4A	
	Power factor	PF>0.98/230Vac, at full load	
	THD	230Vac@THD<6%, at full load	
	Efficiency (typ.)	88%	87%
	Inrush current(typ.)	Cold start 30A at 230Vac	
	Control surge capability	L-N: 2kV	
Leakage current	Max. 0.5mA		
ENVIRONMENT	Working temperature	ta: -20 ~ 50°C tc: 90°C	
	Working humidity	20 ~ 95%RH, non-condensing	
	Storage temp., humidity	-40°C ~ 80°C, 10-95%RH	
	Temp. coefficient	±0.03%/°C(0-50°C)	
	Vibration	10-500Hz, 2G 12min./1cycle, period for 72min. each along X, Y, Z axes.	
PROTECTION	Over-heat protection	Intelligently adjusting or turning off the output current if the PCB temperature ≥110°C, auto recovers.	
	Over load protection	Shut down the output when current load ≥102%, auto recovers.	
	Short circuit protection	Shut down automatically if short circuit occurs, auto recovers.	
	Over voltage protection	Shut down the output when non-load voltage ≥26V, re-power on to recover after fault condition is removed.	Shut down the output when non-load voltage ≥13V, re-power on to recover after fault condition is removed.
SAFETY & EMC	Withstand voltage	I/P-O/P: 3750Vac	
	Isolation resistance	I/P-O/P: 100MΩ/500VDC/25°C/70%RH	
	Safety standards	IEC/EN61347-1, IEC/EN61347-2-13	
	EMC emission	EN55015, EN61000-3-2 Class C, IEC61000-3-3	
	EMC immunity	EN61000-4-2,3,4,5,6,8,11, EN61547	
	Strobe test standard	IEEE 1789	
OTHERS	Dimension	293×43×30mm(L×W×H)	
	Packing	296×44×33mm(L×W×H)	
	Weight(G.W.)	350g±10g	

\* The driver is suitable for connecting resistor current-limiting LED fixture (e.g. LED strip). The inrush current will be dozens of times increased if connecting built-in constant current IC current-limiting LED fixtures, the driver will activate the overloaded protection (hiccup flickering). When you order, please remark controlling the constant current LED fixture (e.g. MR16 lamp, underground light, LED wall washer, constant current LED strip, etc.), then we can prepare the special programs.

## Dimensions

Unit: mm

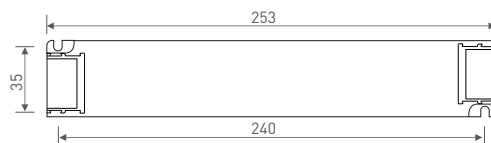
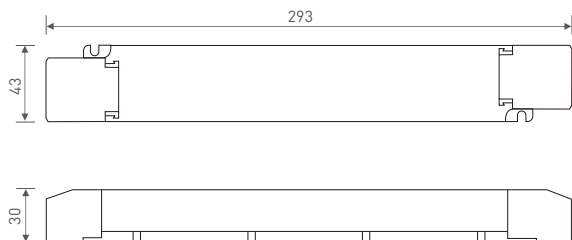

## Wiring diagram

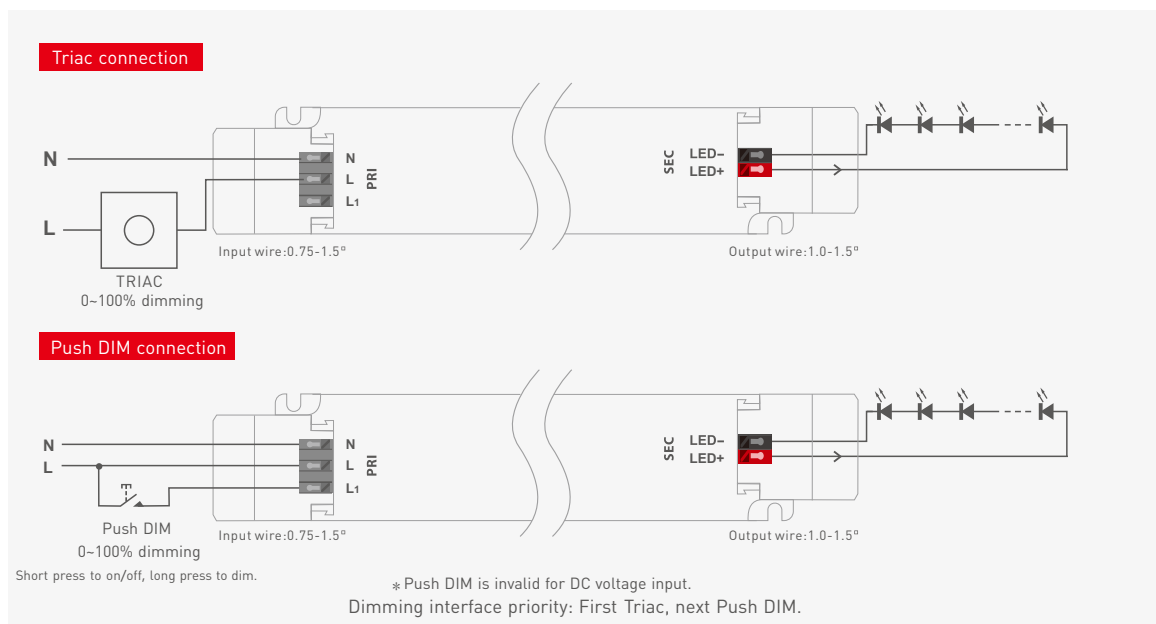

## Push dimming



Reset switch

- On/off control: Short press.
  - Stepless dimming: Long press.
  - With every other long press, the brightness goes to the opposite direction.
  - Dimming memory: The lights will return to its previous brightness value when short press on PUSH DIM button.
- Power on again after power cut, the output brightness is subjected to the input voltage of drivers.

## Application of protective cover

Wire pressing board:

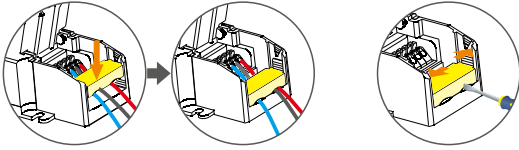

Push the wire pressing board to fix the wire.

Push outward the side plate, meanwhile use the tool to uninstall the wire pressing board.

Uninstall protective cover:

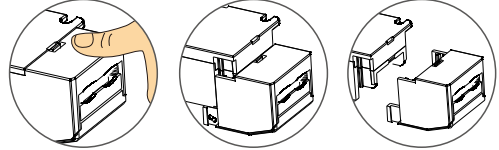

Break off the bottom left and right to remove the protective cover.

## Relationship diagrams

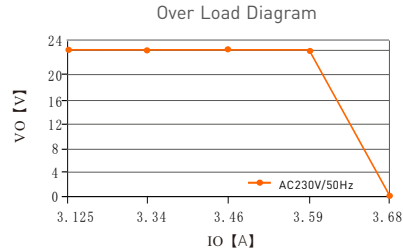
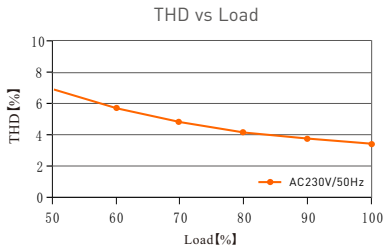
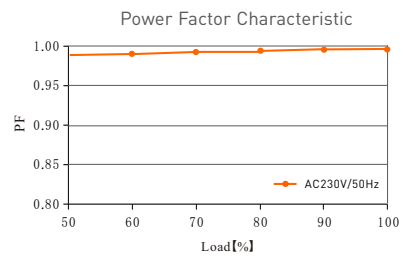
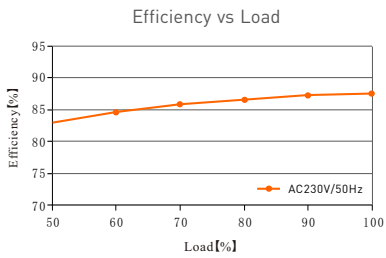

LM-75-24-G1T2

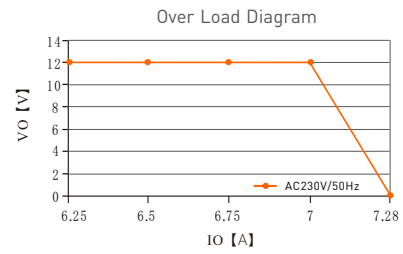
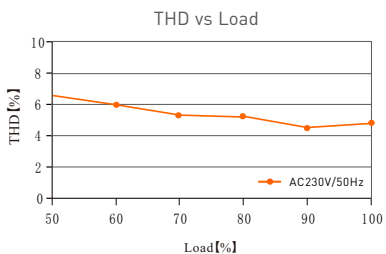
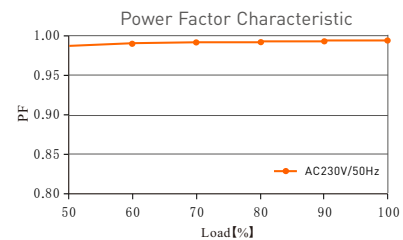
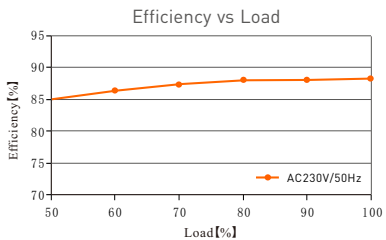

LM-75-12-G1T2

## Flicker Test Form

### IEEE 1789

Limit of Modulation in low risk area	
Waveform frequency of Optical output	limit (%)
$f \leq 8\text{Hz}$	0.2
$8\text{Hz} < f \leq 90\text{Hz}$	$0.025 \times f$
$90\text{Hz} < f \leq 1250\text{Hz}$	$0.08 \times f$
$f > 1250\text{Hz}$	Exemption assessment
Limit of Modulation in no effect area	
Waveform frequency of Optical output	limit (%)
$f \leq 10\text{Hz}$	0.1
$10\text{Hz} < f \leq 90\text{Hz}$	$0.01 \times f$
$90\text{Hz} < f \leq 3125\text{Hz}$	$(0.08/2.5) \times f$
$f > 3125\text{Hz}$	Exemption assessment (High frequency exemption)

- Brightness**
- ▲ 0.1%
  - ◆ 1%
  - ▲ 5%
  - ◆ 10%
  - 20%
  - ▲ 30%
  - 40%
  - ★ 50%
  - 60%
  - 70%
  - ★ 80%
  - ★ 90%
  - ◆ 100%

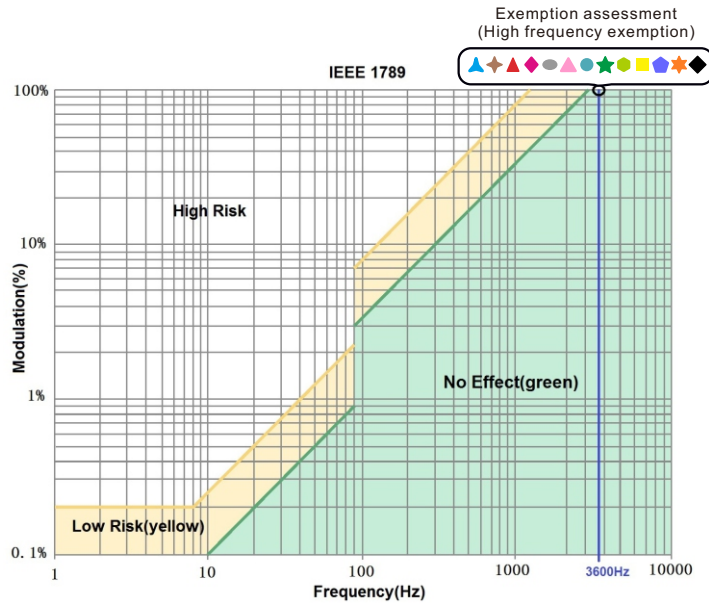

\* No further notice if any changes in the manual. Product function depends on the goods. Please feel free to contact your supplier if any question.