

# Matter Over Thread + Zigbee Dual Tech RGBCCT LED Controller

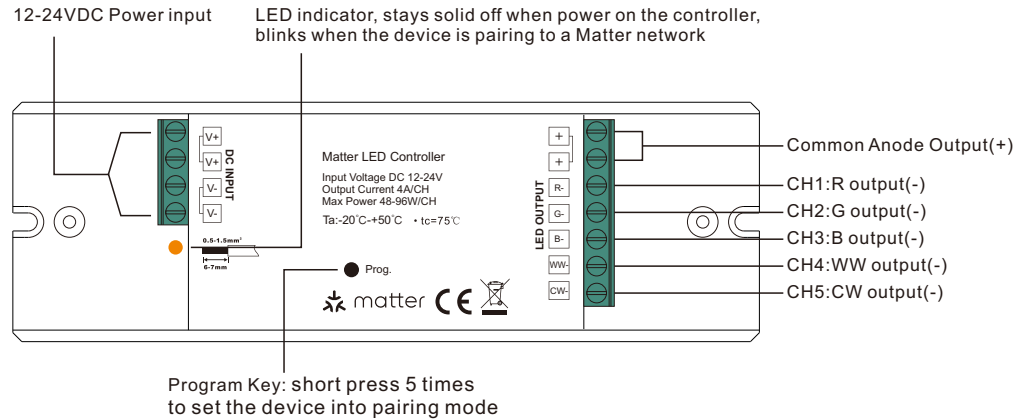

**Important:** Read All Instructions Prior to Installation

## Function introduction



## Product Data

Input Voltage	Output Current	Output Power	Remarks	Size(LxWxH)	Ambient Temperature	Max. Casing Temperature
12-24VDC	4A/CH	48-96W/CH	Constant voltage	145x46.5x16mm	-20°C ~ +50°C	75°C

## Product Features

- Matter over thread + Zigbee dual tech, Matter certified light devices
- Communication via an IPv6 Thread Network
- App control + touchlink remote control + green power kinetic switch control
- App control through Matter (e.g. Apple Home, Amazon Alexa, Google Home)
- Controls RGB + tunable white LED lights
- Fully compatible with universal Matter ecosystems from different manufacturers
- Thread Border Router is required (e.g. Apple HomePod mini or Google NestHub)
- Easy commissioning and pairing by scanning the QR code
- Remote control through Zigbee touchlink remotes or wall switches
- Kinetic switch control through Zigbee green power switches
- Can be voice controlled through Apple Siri, Google Assistant, Amazon Alexa
- Eliminates the shortcoming of Matter having few remote and wall switch devices
- Wireless firmware updates possible
- Waterproof grade: IP20

## Safety & Warnings

- DO NOT install with power applied to device.
- DO NOT expose the device to moisture.

## Operation

1. Do wiring according to connection diagram correctly.
2. This Matter thread device is a wireless receiver that communicates with a variety of Matter compatible systems. This receiver receives and is controlled by wireless radio signals from the compatible Matter system.
3. Add to a Matter border router and control through the Matter platform:

**Note:** an Apple HomePod mini is used as a Matter border router for adding and controlling the device. For other Matter border routers, please refer to their user manuals to learn how to add and control Matter devices.

**Step 1:** Prepare an iPhone (iOS 16.2 or later) or iPad (iPadOS 16.2 or later) with the latest version firmware, and prepare an Apple HomePod mini with the latest version firmware.

**Step 2:** Connect the iPhone or iPad to your home WLAN network. Run the Apple Home app and set up the HomePod mini as instructed by Apple (as shown in **Figure 1** to **Figure 7**).

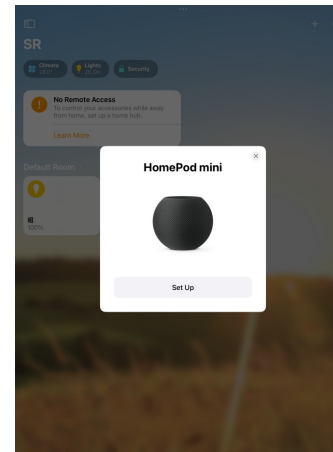

Figure 1

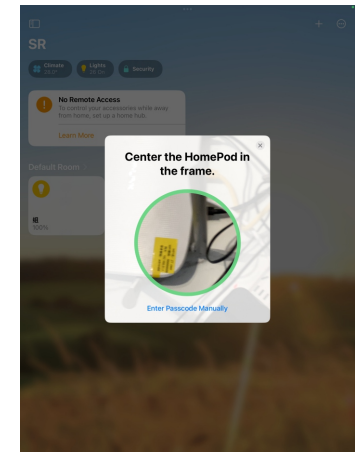

Figure 2

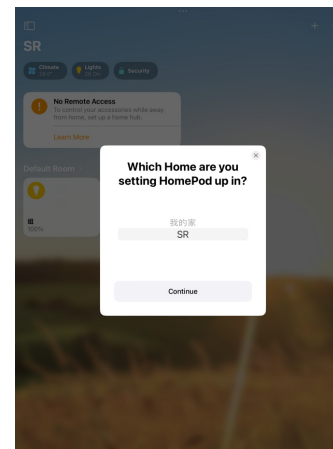

Figure 3

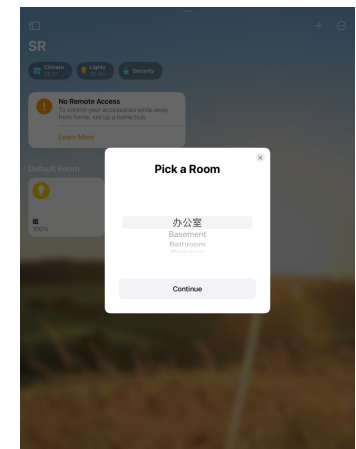

Figure 4

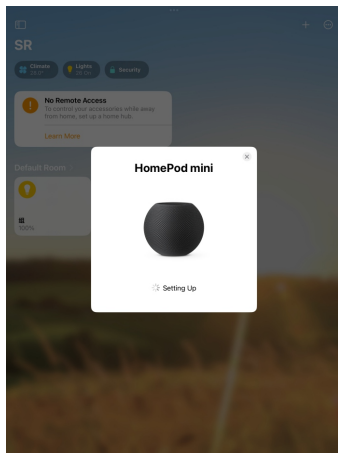

Figure 5

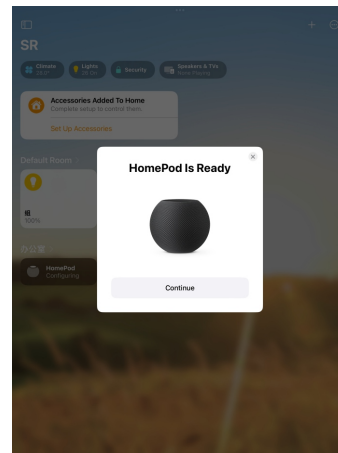

Figure 6

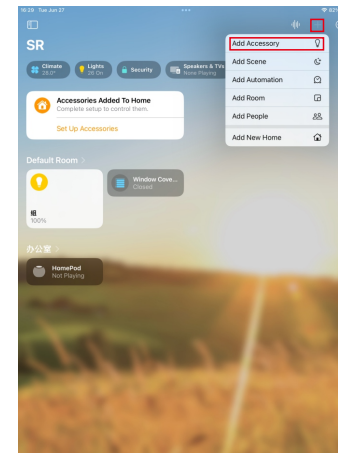

Figure 8

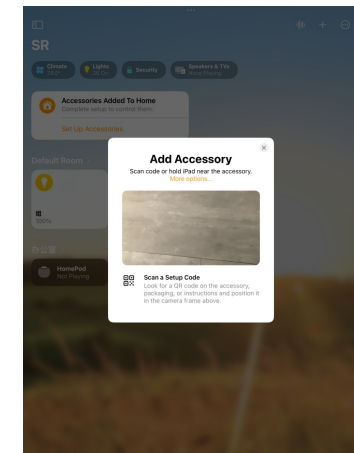

Figure 9

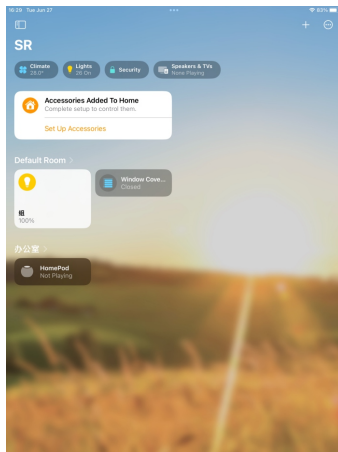

Figure 7

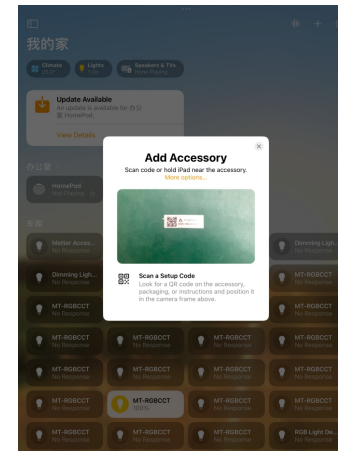

Figure 10

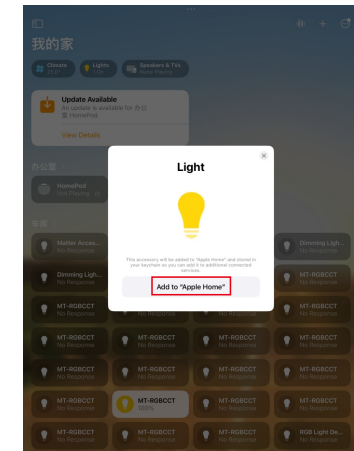

Figure 11

**Step 3:** Do wiring of the Matter LED controller according to the wiring diagram and power on it.

**Step 4:** Short press the Prog. button 5 times to set the LED controller into pairing mode.

**Step 5:** Add the Matter LED controller to the Apple Home app by scanning the QR code sticker on the LED controller as shown in **Figure 8** to **Figure 15**.

**Note:** before scanning the QR code sticker on the dimmer as shown in **Figure 10**, short press the Prog. button 5 times to set the LED controller into pairing mode so that it can be discovered by the Apple Home app. Otherwise it can not be discovered by the Apple Home App.

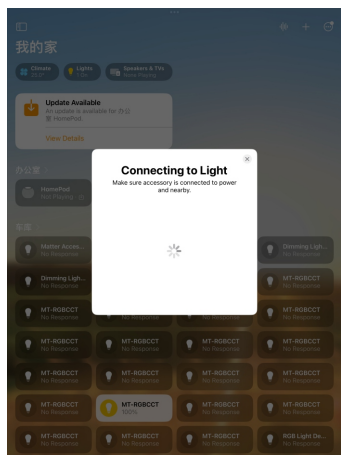

Figure 12

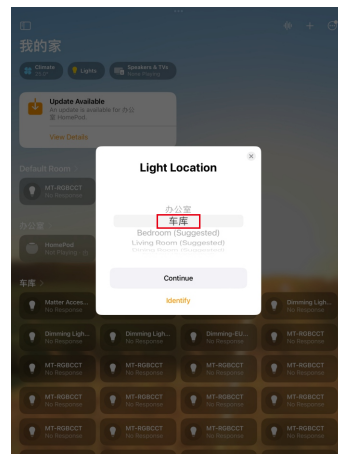

Figure 13

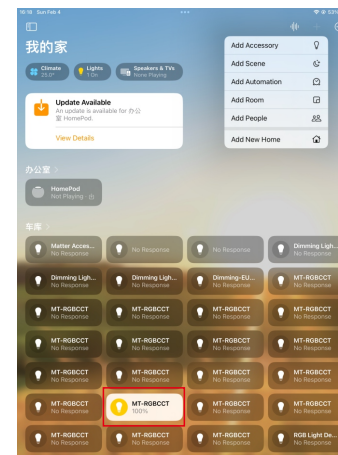

Figure 16

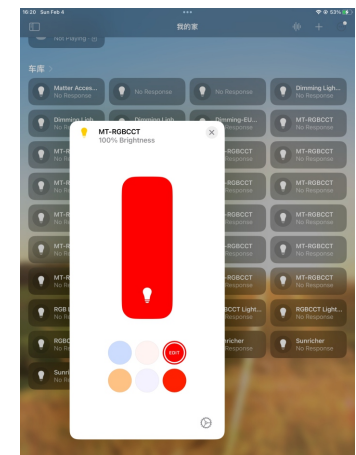

Figure 17

**Step 6:** once the LED controller is added to the border router successfully, tap on the device to control on/off, and press and hold device icon to enter into brightness and color control interface as shown in **Figure 16** to **Figure 17**.

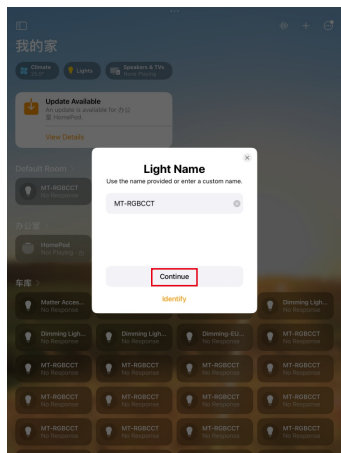

Figure 14

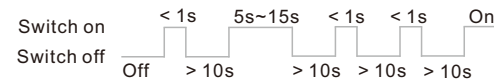

Figure 15

**Note:** when choose the room that you would like to add the LED controller to, please make sure to choose the same room that the HomePod mini is located as shown in **Figure 13**.

#### 4. Restore factory settings

To restore the factory settings, short press the “Prog.” button 5 times or switch the device power on and off in the following sequence.



#### 5. Touchlink to a Zigbee remote

**Step 1:** Short press “Prog.” button 4 times to start Touchlink pairing.

**Step 2:** Bring the remote within 10cm of the receiver.

**Step 3:** Set the remote into Touchlink pairing, please refer to its manual.

**Step 4:** There shall be indication on the remote for successful link and the connected light will flash.

**Note:** There are two control situations:

**1. Only one remote, to control one or more receivers:** directly perform Touchlink pairing between the remote and the receiver.

**2. Only one receiver, to be controlled by multiple remotes, or multiple remotes and multiple receivers with cross-control:** use one receiver as the Zigbee hub, add all remotes and other receivers to the hub, and then perform Touchlink pairing between the remotes and the receivers. The steps are as follows:

**Step 1:** Use one receiver as the Zigbee hub and short press “Prog” button 4 times to start adding Zigbee devices.

**Step 2:** Reset power of another receiver once to enter Zigbee network pairing mode, it will be added by the hub, and the connected light will flash.

**Step 3:** Set a Zigbee remote to enter Zigbee network pairing mode, it will be added by the hub, and the indicator will flash to indicate.

**Step 4:** Add more receivers and remotes to the hub as you would like, refer to the corresponding remote manual.

**Step 5:** Touchlink the added receivers and the remotes.

## 6. Learning to a Zigbee Green Power Switch

**Step 1:** Short press "Prog." button 4 times to start Learning mode.

**Step 2:** Set the green power switch into Learning mode, please refer to its manual.

**Step 3:** There shall be indication on the switch for successful learning.

**Note:** There are two control situations:

**1. Only one receiver, to be controlled by multiple GP switches:** directly perform pairing between the GP switch and the receiver.

**2. Only one GP switch, to control multiple receivers, or multiple GP switches and multiple receivers with cross-control:** use one receiver as the Zigbee hub, add all other receivers to the hub, and then pair the GP switch with the receiver. The steps are as follows:

**Step 1:** Use one receiver as the Zigbee hub and short press "Prog." button 4 times to start adding Zigbee devices.

**Step 2:** Reset power of another receiver once to enter Zigbee network pairing mode, it will be added by the hub and the connected light will flash.

**Step 3:** Add more receivers to the hub as you would like.

**Step 4:** Pair the added receivers with the GP switches.

## Wiring Diagram

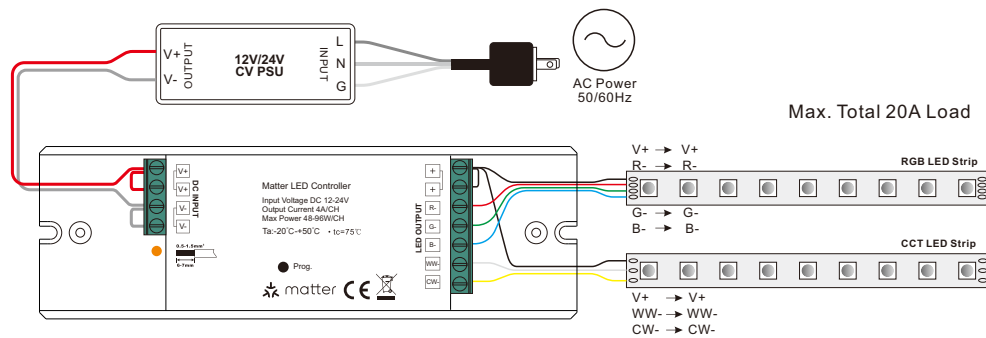

## Product Dimension

